

**bigla**

büromöbel  
**JOMA**  
aadorf

JOMA-Trading AG  
Weiernstrasse 22  
8355 Aadorf  
Telefon (052) 365 41 11  
Telefax (052) 365 20 51  
email: [info@joma.ch](mailto:info@joma.ch)  
[www.joma.ch](http://www.joma.ch)



**factsheet**  
**RollladenBox2**

# Bigla RollladenBox2

Das Organisationssystem BMBox2 gefällt im Raum als elegantes Gestaltungselement, das Struktur und Privatsphäre schafft. Die Rollläden der RollladenBox2 sind in den Versionen hell, dunkel und Ton in Ton erhältlich. Dazu kommen transluzide Rollläden, die

einen modernen, schwerelosen Akzent setzen. Optional sind die Rollläden und Möbelrücken in akustisch wirksamer Ausprägung erhältlich. Die Parallelführung sowie optionale Dämpfung der Schubladen garantieren für eine optimale Laufruhe der Schubladen.



# Bigla RollladenBox2

## Produkt-Highlights

1 Hochwertige Stahlkonstruktion

2 Hohe Laufruhe der Schubladen,  
optionale Dämpfung

3 Schliessung nachrüstbar

4 Innenleben nachrüstbar

5 Hohe Stabilität, Langlebigkeit

6 100% rezyklierbar

7 Farbakzent: kubisch und konstruktiv,  
Rollladen transluzid

8 Option: Akustik-Rollladen, Akustik-Rücken

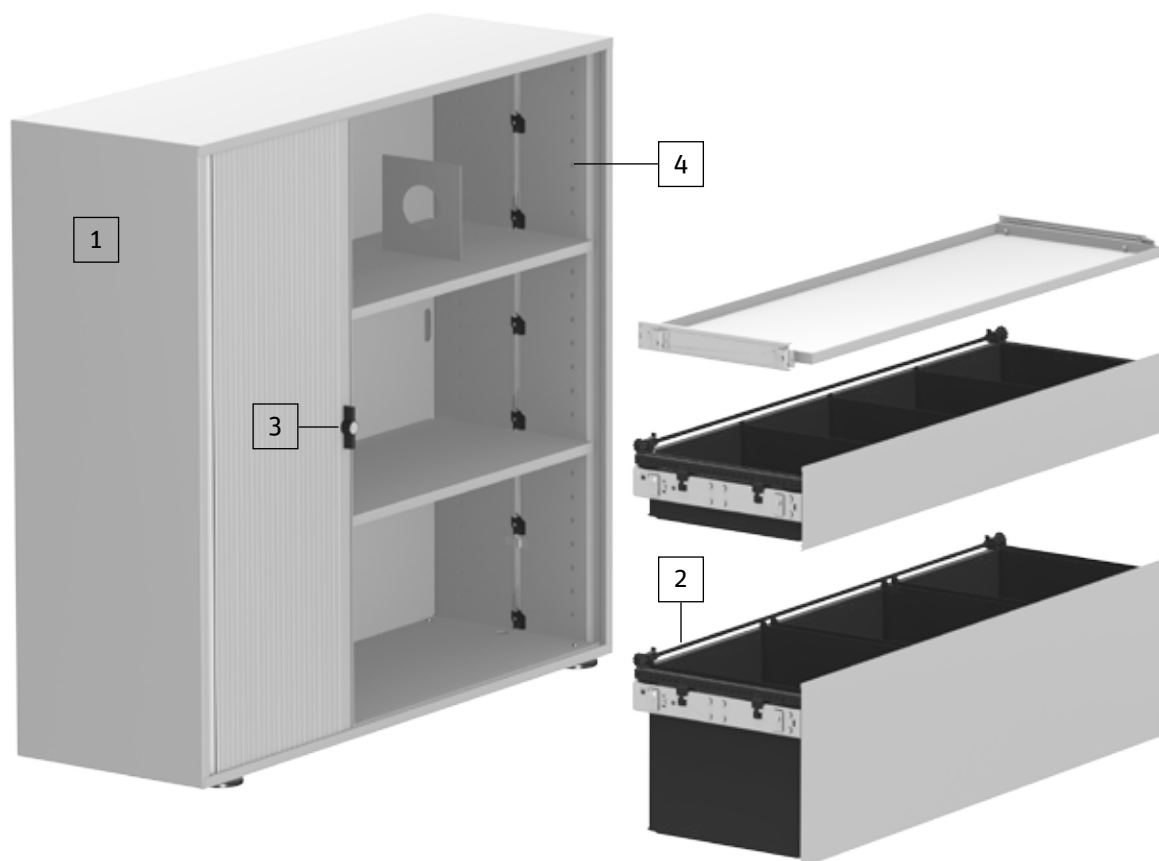

# Bigla RollladenBox2

## Produktübersicht

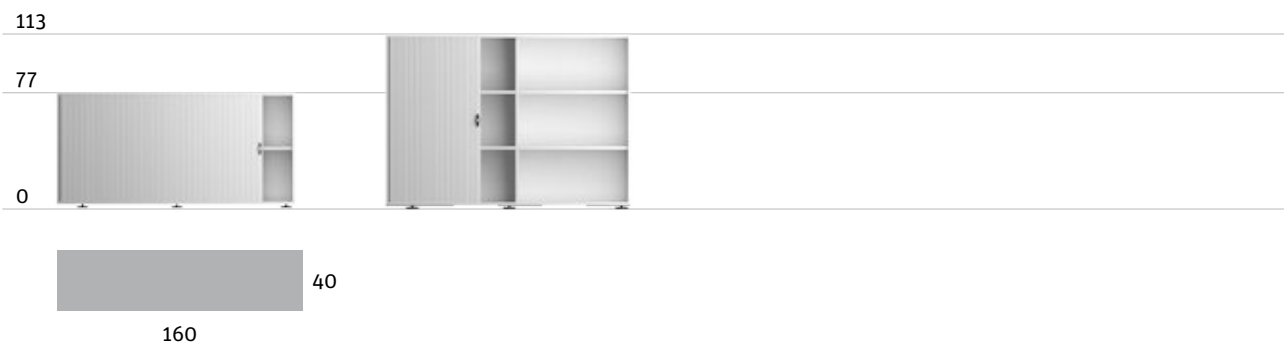
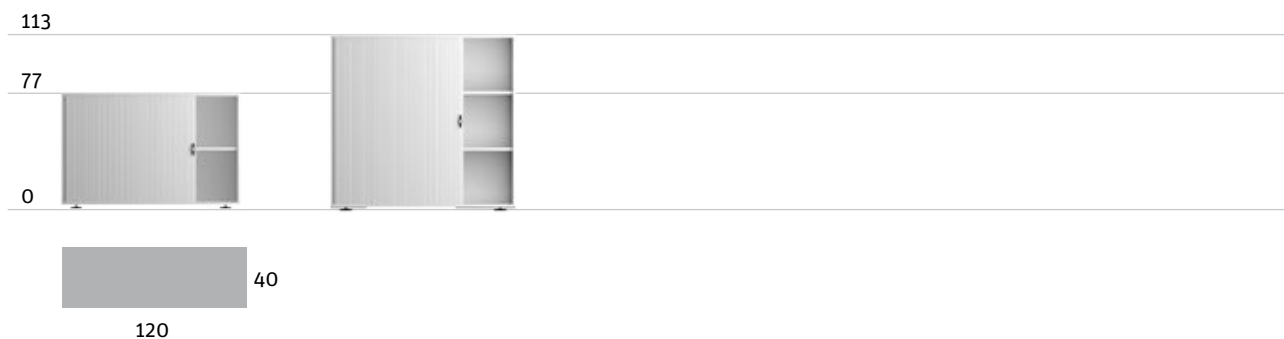

# Bigla RollladenBox2

## Produktzubehör



Bücher-Halter

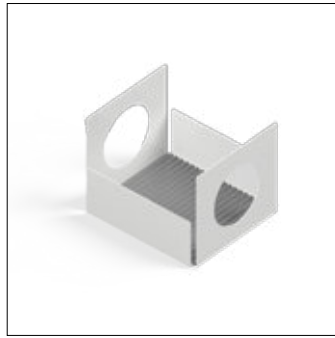

CD-Halter



Ordner-Halter



Halter magnetisch

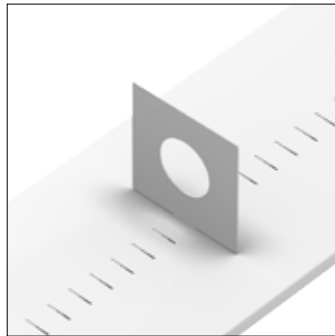

Steckplatte

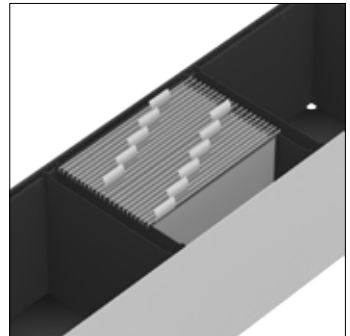

Schublade A4

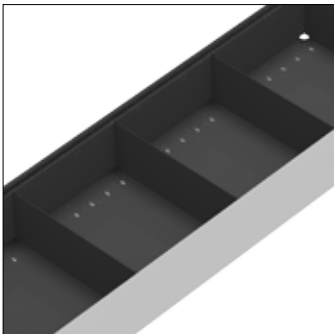

Längswand

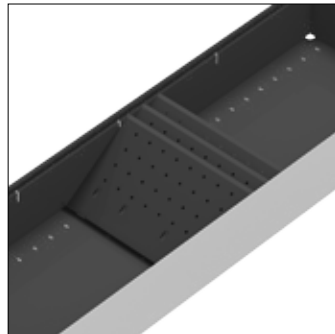

Formularschrägplatte

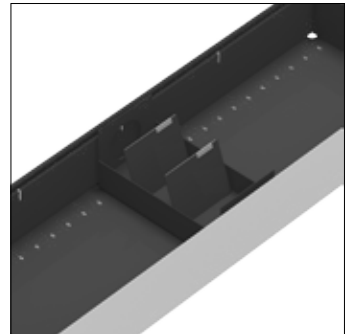

Kartei mit Schwingplatte

# Bigla RollladenBox2

## Produktzubehör

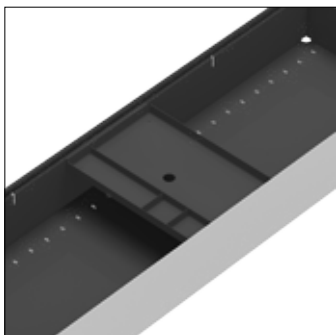

Materialschale

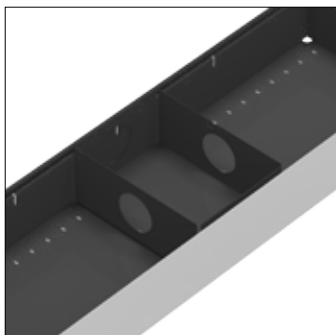

A4-Box

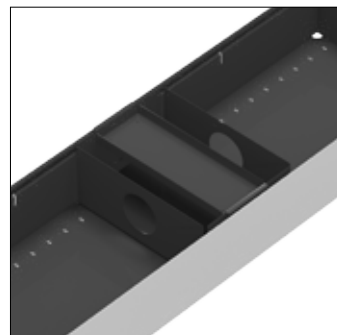

Materialschale klein



Rückwand Mikrolochung



Abdeckplatte

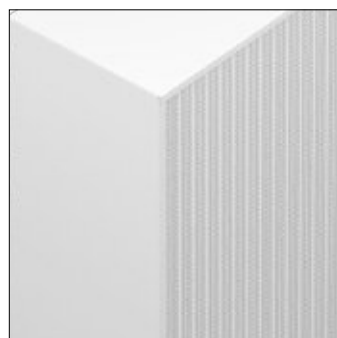

Akustik Rollladen

Produktdesign: Andreas Bürki

## Material und Farben

Metall



Abdeckplatten  
Kunstharz  
beschichtet



Abdeckplatten  
Holzfurnier

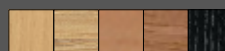

Abdeckplatten  
Linoleum



Abdeckplatten Vollkern siehe Preisliste